

INSULATION



INSIDE

INSULATION CHECKLIST	4
VENTILATION	6
ATTICS	8
BASEMENTS	11
FLOORS	14
WALLS	16
AIR DUCTS	17

The average Arkansas household spends more than half of its annual energy bill on heating and cooling. These costs can be drastically reduced by using energy wisely and making energy-efficient home improvements. Insulating your home is a major step toward reducing energy costs.

INSULATION



What Is It and How Can It Save Energy?

Insulation is a material used to slow down heat flow through a building's envelope. The building envelope consists of the walls, attic/roof, windows and floor of a home — basically everything that surrounds the space you want to keep warm in the winter and cool in the summer.

Insulation works all year long to make your home more comfortable and energy efficient. In the winter, it slows heat loss and helps prevent condensation build up in your home. During summer months, insulation reduces heat gain and helps keep your home cool.

Adding insulation to your home can cut your heating and cooling costs anywhere from 15% to 45% depending on such factors as the original amount of insulation in your home, house size, air leaks, and personal energy use and living habits. Many variables affect the amount you'll save, but the fact remains, insulating your home is an energy-wise investment.

Financing Energy Improvements

Consider making energy improvements when refinancing. They may also be included when applying for a home improvement loan. The Energy Improvement Mortgage (EIM) was developed by the lending industry to give the buyer of an existing home the opportunity to borrow more money at the time of sale or refinancing to make their home more energy-efficient. The lending industry now recognizes that saving energy reduces the cost of home ownership and frees up more money to assist in paying the mortgage, in addition to increasing the comfort, durability and value of the home.

The extra dollars borrowed to add additional insulation, replace the old heating/cooling system, or tighten the home are rolled into the new mortgage and spread over the mortgage term (usually 30 years).

Tighten Before You Insulate

Before insulating, it's necessary to stop air leaks in your home. While insulation is an important step, controlling air leaks is the best way to extend the life of your home, as well as save energy, money and increase your home's comfort. *If you don't tighten up your home first, money spent on insulation may be wasted.*

Most people think they should caulk the outside of their home to protect it from the elements. This is true, but it is also important to protect your home from losing conditioned air to the outside. During the winter months, moist interior air can enter the walls and ceiling through cracks and holes causing condensation to build up in the walls, damaging or destroying the insulation, wiring, wood and other building materials.

There are many places where air can leak into and out of your home. A good rule of thumb is to seal the attic and basement air leaks first. The check list below will help you locate common trouble spots. For more detailed information on caulking and weatherstripping, consult the *Home Series* issue *Home Tightening*.

Air Leak Trouble Spots

The Attic:

- Holes in the attic floor and walls
- Doors and hatches to the attic
- Plumbing stacks
- Attic knee walls/storage drawers

The Basement:

- Around the sill plate and band joists
- Basement windows
- Ducts/furnace ducts
- Openings in the basement ceiling and other holes

The Main Level:

- Around the chimney and fireplace dampers
- Around windows, doors, trim and baseboards
- Electrical outlets and other exterior wall holes

The Outside:

- Cracks in siding and exterior
- Windows and doors

Before You Get Started

Whether you do it yourself or hire a professional, insulation can be added to almost any home. While every house is different, the basic rule of insulating is the same for all homes: ***Insulation should be installed on any surface separating a heated space from an unheated space.*** Figure 4 shows the areas of a house that should be insulated.

Recommendations for the amount of insulation to install vary according to such factors as climate conditions, the area of your home being insulated and the kinds of materials used in your home's construction. The following insulation checklist gives recommendations for a typical Arkansas home. Of course, not all houses have all of the building elements shown. Note: Even if a house already has some insulation in these areas, it may not be enough.

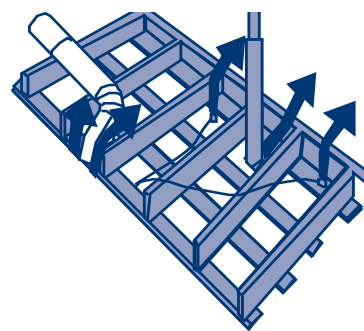

Figure 1: Recessed lights, wiring, plumbing and other openings in insulated ceilings and walls can result in a tremendous amount of heat loss.

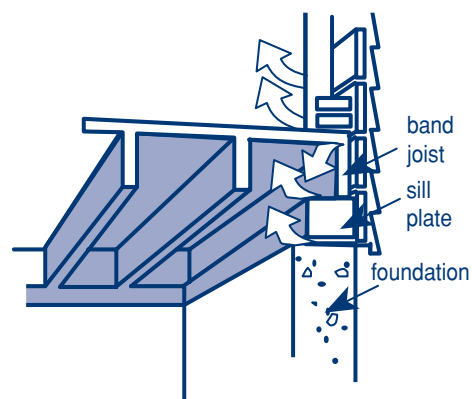

Figure 2: Get rid of drafts along the floor by caulking along the sill plate and band joist in the basement.

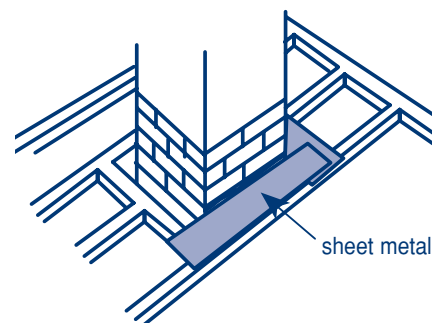

Figure 3: Heat can escape around the chimney if it isn't properly sealed.

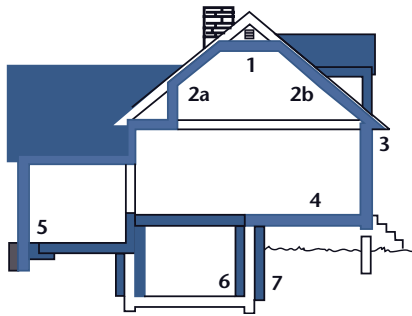

Figure 4: Where to insulate.

- 1—Ceilings/Attics (also Dormer ceilings) with cold spaces above: R-30-38.
- 2a-2b—Rafters and/or knee walls of a finished attic: R-19+.
- 3—Exterior walls; walls between heated and unheated spaces; dormer walls: R-13.
- 4—Floors over open or unheated basement/crawl spaces: R-19+.
- 5—Perimeter of a concrete slab close to grade level: R-5, interior or exterior.
- 6/7—Interior or exterior of a finished or heated basement: R-7.

Understanding R-Values

Insulation is rated by R-values. The R-value (or thermal resistance) of insulation is a measure of its ability to resist heat loss or heat gain. The higher the R-value, the better it insulates. It is important to note that an insulation's R-value is based on its performance in a 70°F environment with no air movement. Ironically, when you need insulation the most, it is not under those ideal temperatures or conditions.

Therefore, the *rated* R-value may be much higher than the *effective* R-value if the insulation is not properly installed and/or if air leaks are not stopped before the insulation is added. Some types of insulation, such as blown-in wet cellulose and polyurethane and polycynene insulation combine both air sealing and insulation in one step. These products' rated and effective R-values are very similar, and they have a good performance record.

Insulation Checklist

Shown below are different surfaces which, if found in your home, should be insulated to the suggested R-values for Arkansas.



- Ceilings/attics (also dormer ceilings) with cold spaces above: **R-30 to R-38.**
- Rafters and knee walls of a finished attic: **R-19 or more.**
*Note: Air can bypass knee walls and follow the length of the rafters. Use extra caution to get insulation to the outer ends of the rafters to create a sealed area.
- Exterior walls, walls between heated and unheated spaces; dormer walls: **R-13 or more.**
- Floors over open or unheated crawl spaces: **R-19 or more.**
- Floors over unheated basements (basements with no boiler, furnace or woodstove): **R-19 or more.**
- Perimeter of a concrete slab close to grade level: **R-5 or more.**
- Interior of a finished or heated basement: **R-7 to R-10 or more.**
- Exterior of a finished or heated basement: **R-7 to R-10 or more.**

Choosing the Right Insulation

Any material with a relatively high resistance to heat flow can be considered an insulator. See Table A for more details on the various forms and types of insulation.

Sprayed Insulation: Includes polyurethane, polycynene and wet, dense-packed cellulose and requires professional installation. Wet cellulose is used in open walls and attics. Polyurethane and polycynene can be used for both finished and open walls, attics and on the undersides of floors. Both seal air leaks and insulate in one step and have a high effective R-value.

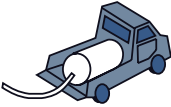
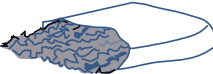
TABLE A: INSULATION TYPES AND CHARACTERISTICS

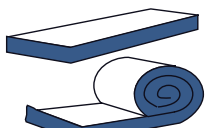
Type	Model	Rated-Value Per Inch	Where To Use
Sprayed 	Polyurethane Polyisocyanate (Icynene) Wet dense packed cellulose	R-4.7 per inch R-3.6 per inch R-3.7 per inch	Open frame walls, floors and ceilings, around windows and doors; used both during construction and renovation.
Loose fill 	Fiberglass or Rock Wool Vermiculite Cellulose	R-2.7 per inch R-1.8 per inch R-3.7 per inch	Unfinished attics, uninsulated and existing walls
Rigid board 	Expanded Polystyrene (Beadboard) Extruded Polystyrene Polyurethane or Polyisocyanurate	R-4.2 per inch R-5 per inch R-7.2 per inch	Basement walls, new construction frame walls; commonly used between siding and studs, cathedral ceilings
Batts & Blankets 	Fiberglass Rock Wool	R-3/in.—low density R-3.8/in.—medium density R-4.3/in.—high density	Unfinished attics, rafters, underside of floors, between studs

Sources: Cooperative Extension Service, U.S. Dept. of Energy.

Loose Fill (poured in): Fiberglass, mineral wool, cellulose. Used for unfinished attic floors.

Loose Fill (blown in): Fiberglass, mineral wool or cellulose (dry). Used for unfinished or finished attic floors, undersides of floors and finished frame walls. There can be problems with settling.

Rigid Board: There are four main types:

- Expanded polystyrene (Bead Board)
- Extruded polystyrene (Styrofoam)
- Polyurethane
- Polyisocyanurate

Used primarily on wall framing, under concrete slab floors and on masonry basement walls. To ensure fire safety, these materials must be covered with fire-rated gypsum wallboard. To achieve a high effective R-value, seams must be taped.

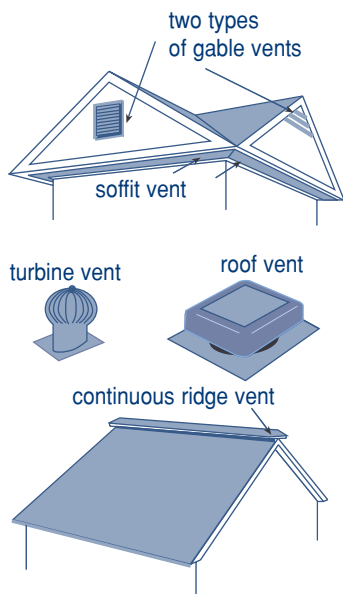

Figure 5: Five common attic vent types.

Batts/Blankets: Includes fiberglass and mineral wool, with or without vapor barriers. Used to insulate unfinished attics, undersides of floors and open walls. Blankets are more difficult to handle than batts because of their size. A tight fit is necessary to gain a high effective R-value; not appropriate for air sealing around windows and doors.

Shopping for Insulation

It is important to remember when buying insulation that the product with the highest R-value per inch may not be the most cost-effective. For example, when insulating a basement wall to an R-12 value, using 3 inches of an R-4 per inch insulation material might be less expensive than using 2 inches of an R-6 per inch product. To get the most insulating value for your money, compare the total costs of insulating an area with the same R-value.

Should You Install Your Own Insulation?

For many insulating jobs, such as those in your attic and basement, doing it yourself can save you money. However, some jobs — insulating walls and foundations, for example — are more difficult and time-consuming. In those cases, professional installation may be a wise choice.

Vapor Barriers

Since Arkansas is in a “mixed-humid” environment, it is not recommended that a vapor barrier be installed on the “warm side of the wall.” During the heating season, the flow of water vapor is from the interior to the exterior, and in the cooling season vapor passes from the exterior towards the interior. In the cooler northwest part of the state, a vapor barrier is optional. In Arkansas’ climate, the warm side changes from season to season. It is important to allow moisture to pass through the walls by using permeable building materials (materials or techniques that allow water vapor to pass through) on both the interior and exterior surfaces. This allows water vapor to “flow through” the building assembly without accumulating inside the wall or other surface.

VENTILATION

Tightening up a house with caulking and weatherstripping, sealing ducts and insulating can have a significant effect on the way a house operates and greatly increase your comfort. However, as the home becomes tighter and tighter, it is important to pay attention to ventilation—exchanging indoor air with outdoor air. Signs that additional ventilation is required: lingering odors, stuffiness and condensation on windows.

Spot Ventilation

Normal cooking and bathing typically produce excessive moisture in the home. “Spot ventilation” is the use of localized fans (e.g. kitchen and bath fans) to quickly remove pollutants at their source as they are generated. Building codes may provide specific requirements concerning spot ventilation. Recommended ventilation rates are: 50 cfm (cubic feet per minute) for bathrooms, and 100 cfm for kitchens. Consult with local code officials before sizing and installing spot ventilation systems in your home

Ventilation in Attics and Crawl Spaces:

Proper ventilation is also important to protect your home from moisture damage. It reduces problems with condensation or moisture build-up on the roof during the winter and can reduce cooling costs in the summer by 10% or more.

Much of the moisture that accumulates in attics during cold weather comes from air leaks between the home and the attic. Warm moist air from the home rises through unsealed holes, and water vapor can condense out of the air as it cools. Moisture in an unvented attic won't be able to pass through the roofing materials and will be trapped in your attic where it can damage building materials.

It is most effective to seal the leaks in the ceiling rather than to rely on attic ventilation to remove the moisture condensation caused by air leaks.

Ventilation, however, is necessary to ensure proper air flow through the attic. First, vents are needed at or near the top of the roof (use roof, gable, turbine or continuous ridge vents). Second, vents should be at the lower edge of the roof (use soffit vents) (Figure 5) to allow air to circulate naturally. A combination of high and low vents or continuous soffit vents and continuous ridge venting is the most effective option (Figure 6).

Good natural ventilation makes attic fans unnecessary. Insulated attics without a vapor barrier need one square foot of vent area for every 150 square feet of ceiling area (Figure 6).

Crawl spaces containing water pipes or other utilities should have vents to the outdoors that can be opened in the summer and, if there are no air combustion devices in the crawl space, closed tightly in the winter to reduce heat loss. Vents at each corner of the crawl space or basement area provide the best air circulation.

Mechanical Ventilation:

Power attic ventilators are sometime used as a last resort to solve moisture problems and cool attics. Often these fans are overpowered and can draw a home's conditioned air through cracks in the ceiling to replace the large volume of air blown out of the attic. Turbine vents can usually do the job and require no electricity.

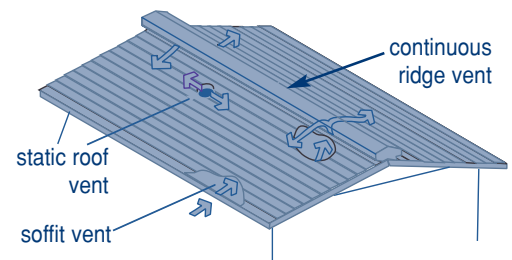

Figure 6: Effective attic ventilation. Intake venting low through the soffit and exhaust venting high through a continuous ridge vent are the most effective way to ventilate an attic.

Whole-house fans pull in a large amount of humid, pollen-filled air. Although useful during those few days a year when Arkansas' climate is warm and dry, the fans lose heat all winter into the attic and leak air all year long. If removal is not an option, then insulate the fan area from below with a sheet of 2-inch-thick Styrofoam. Make sure that the edges are sealed or gasketed to prevent air leakage.

Indoor Air Quality Specialists:

If you have concerns about your house venting properly, consider having a blower door test performed. This test determines if you have proper air pressure in your home and identifies air leaks and ventilation problems. Check your local *Yellow Pages* and look for a contractor or energy specialist who offers a blower door test.

THE ATTIC



Because a significant amount of heat can be lost through the roof, the best place to begin insulating is the attic. This is also usually the easiest place for “do-it-yourselfers” to begin. Access to the attic is usually easy, and loose-fill or batt/blanket insulation can be installed over existing insulation. Other ceiling types, such as cathedral ceilings or finished attics, can be more difficult, and professional installation may be necessary. If you choose to install spray-in insulation, such as polyurethane, polyisocyanurate or wet cellulose, you will need to have it professionally installed. Different types of attics require different methods of insulating. The following pages include information to help you successfully install insulation in your home.

Things to Remember

Before you begin, examine the work area for water leaks or possible hazards, such as protruding nails and exposed wiring. Seal all air leaks and water leaks before adding any insulation. If you find old, brittle wiring, leave it alone and call an electrician to inspect it. Also, make sure your work area is adequately ventilated.

Read the manufacturer's instructions before installing any insulating material. Some of these materials are highly flammable and require special handling. As a fire precaution, do not smoke while working with insulation. You will need the following:

- In an attic without a floor, pieces of lumber long enough to span several joists and wide enough to walk on. The ceiling between the joists is not sturdy enough to support a person.
- Portable light, such as a mechanic's trouble light, and an extension cord.

- Sharp knife or scissors, a rake to push and pull blankets to the edge of the eaves, caulk.
- A long-sleeved shirt with collar and cuffs buttoned, gloves, hat, safety glasses and dust mask.

Insulating an Unfinished Attic

Step 1: Prepare the area. If necessary, lay lumber across ceiling joists to create a platform to work from. Use your portable light to illuminate the work area.

Step 2: Assess the condition of the area.

- If the existing insulation is water damaged, remove it. Examine the roof for leaks and repair. Also, look for any openings in the walls or floor where air could enter. Seal any of these openings with caulk before insulating. When warm, moist air from the home rises, it can condense at the insulation level where it meets the cooler attic air.
- Be on the lookout for wiring that looks old and brittle. Have such wiring checked and replaced, if necessary, by a qualified electrician.

Step 3: Calculate the area to be insulated.

Measure the area to be insulated. Multiply the length by the width to find the area (see Area Table in Appendix, Page 18). After taking into account any existing insulation, calculate how much new material is needed to insulate to the desired R-value.

In Arkansas, unfinished attic floors should be insulated to a minimum of R-30 and up to R-38.

IMPORTANT: If some insulation already exists, the additional insulation **should not** have a vapor barrier. If batts or blankets without facings are not available, you must remove the vapor barrier facing or slash it with a knife before installing it. If you don't do this, the vapor barrier will trap moisture in the insulation.

Insulation is necessary not only over the main part of the floor, but also above stairways and pull-down stairs, around plumbing vents, flues, electric wiring and other holes in the attic floor.

Step 4: Check existing insulation. Before adding additional insulation over existing material, check to see whether the old insulation has a vapor barrier and whether it is in the right place. The vapor barrier should face downward, toward the heated portion of the house. If it's been installed incorrectly, check its condition. If the insulation is dry, turn the batt or blanket so that the vapor barrier faces downward (Figure 7). If more insulation

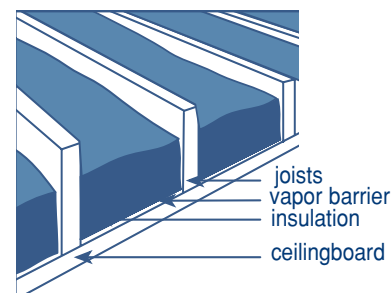

Figure 7

is added, follow the instructions described in (Figure 8 and Figure 9). If it's wet, it must be thrown away.

Step 5: Install the insulation. Insulation should form a snug, continuous barrier over the attic floor, with the only openings around non-IC (insulation contact) recessed light fixtures and soffit vents.

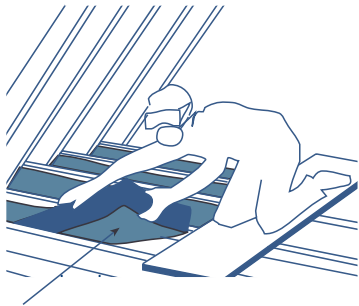

Figure 8: Begin laying insulation at the outer edge of the attic.

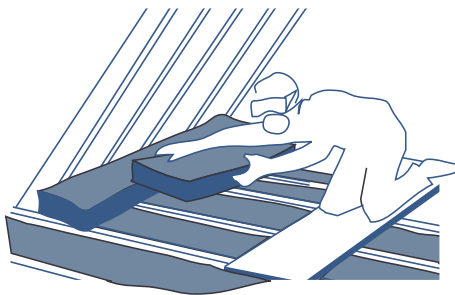

Figure 9: Insulation may be layered over and at right angles to the joists.

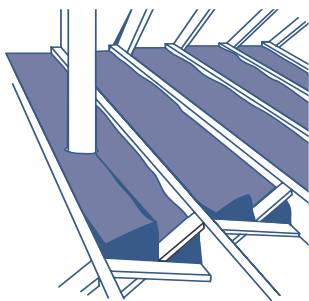

Figure 10: Install insulation snugly around cross braces and protruding objects that don't produce heat.

IMPORTANT: Avoid insulating closer than 3-inches to any older (non-IC) recessed light fixtures, motors, chimneys or other heat source. Newer recessed lights are rated as “insulation contact” (IC), which allows insulation to completely cover them.

When using loose-fill insulation, construct sheet metal barriers around non-IC recessed light fixtures and other such heat-producing protrusions (Figure 11). Also, never block the soffit vents with insulation. If you are using loose-fill material, install baffles to prevent insulation from being poured or blown into the soffit vents. Blocked vents will lead to moisture problems.

For Batts or Blankets

- Begin laying insulation at the outer edge of the attic and work toward the center, placing the insulation between ceiling joists (Figure 8).
- Lay insulation in long runs first, using leftover pieces for shorter spaces. Cut ends of batts or blankets to fit snugly around cross bracing and around plumbing stacks (Figure 10).
- If adding more than one layer, place the second layer over and at right angles to the first layer (Figure 9).

For Loose Fill

- To prevent filling soffit vents with insulation, place pieces of batt or blanket insulation between the ends of joists or use commercial baffles installed according to the manufacturer's directions.
- Spray or tape bright thickness markers on joists or rafters to indicate desired installed thickness.
- If using a blower, start at the far end of the attic and use the blower's hose to fill all the areas between the joists. For a floored attic, use the same procedure, but begin by removing enough center floorboards to allow the blower's hose to be inserted under the floor.
- If using hand-poured material, start at the outer edge of the attic and work toward the center. Periodically level the insulation with a rake or short board and measure its depth.

Insulating a Finished Attic

The same basic methods used for an unfinished attic can be used when insulating a finished attic. It's just more difficult to get the insulation where it's needed.

Follow the first four steps under Insulating an Unfinished Attic (Page 9) Then:

Step 5: If there is no access to the areas behind knee walls and above ceilings, you will need to cut access panels.

Step 6: Install batts behind the knee walls (minimum R-19) and between the floor joists (minimum R-30) in the attic's unfinished portion behind the knee walls. Use small pieces of foam board to prevent attic air from entering the joist area between floors.

Step 7: Blow or pour loose-fill insulation from the top of the sloping portion of the ceiling. The top of the knee-wall batts should hold the insulation in place.

Step 8: Install loose-fill or batt insulation above the flat portion of the ceiling (R-30 to R-38).

Insulating Cathedral Ceilings

Insulating cathedral ceilings, A-frame houses or flat roofs is an especially difficult job because there is little or no space between the ceiling and roof. With these type ceilings, professional installation is recommended. These types of ceilings are also ideally suited to spray-in insulation such as polyurethane, polyisocyanurate and wet cellulose.

- Insulated ceiling panels are a possible solution. The panels are made of insulation batts covered with a vapor barrier.
- Another solution is to build a wood framework to hold the insulation, which is installed against the ceiling, covered with a polyethylene plastic vapor barrier and new drywall. Ventilation of the space between the cathedral and new dropped ceiling may be necessary to avoid condensation.

THE BASEMENT



Uninsulated basements can account for as much as 30% of a home's total heat loss. Some Arkansas homes have basements with either concrete block or poured-concrete walls. While such walls make sturdy foundations, they are poor insulators and have a very low R-value.

Before you begin any insulation projects in the basement, check for moisture problems and air leaks. You can repair minor problems on the inside of the foundation wall with sealant or waterproofing compounds, but any serious water leaks will require more extensive repair. In addition, down spouts should be in good order and there should be a sufficient amount of fill dirt around the foundation to ensure water drains away from the house.

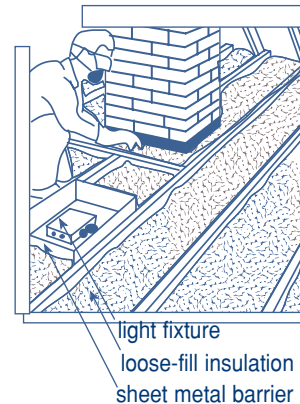

Figure 11: Take precautions when insulating around chimneys and heat-producing protrusions, such as non-IC rated light fixtures. Additionally, make sure the insulation doesn't block vents.

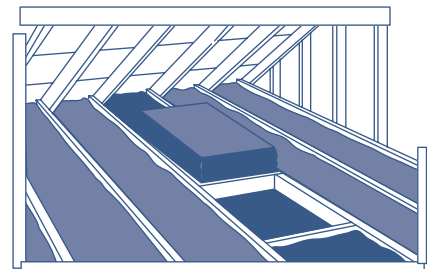

Figure 12: Cover sliding panels and attic doors with insulation.

Band Joists

The band joist area (where the house's wooden structure rests on the cement foundation) is the best place to begin not only because it's the simplest and least expensive basement area to insulate, but also because it brings the fastest return on your investment.

The wooden joists and other building materials offer only token resistance to heat flow from your basement. The band joist area should be insulated to R-19 (Figures 13 and 14).

How-To Instructions:

On walls that run at right angles to the floor joists.

Step 1: Caulk any air leaks.

Step 2: Measure and cut insulation to cover the joist and sill area between each floor joist.

Step 3: Cover the sill and band joist by pressing the insulation pieces into place without tightly compressing them.

Step 4: Staple the insulation to the sides of the joists and to the sill, with the attached vapor barrier facing you.

On walls running parallel to the floor joists.

Step 1: Because the full length of the band joist is exposed, use long insulation strips.

Step 2: Lay the insulation in place along the band joist, cutting off the excess width, but leaving it slightly wider than the band joist.

Step 3: Staple the insulation to the sill and the floor above at 4-inch intervals. Again, the vapor barrier should be facing you. Caulk the vapor barrier edges to prevent condensation behind the insulation.

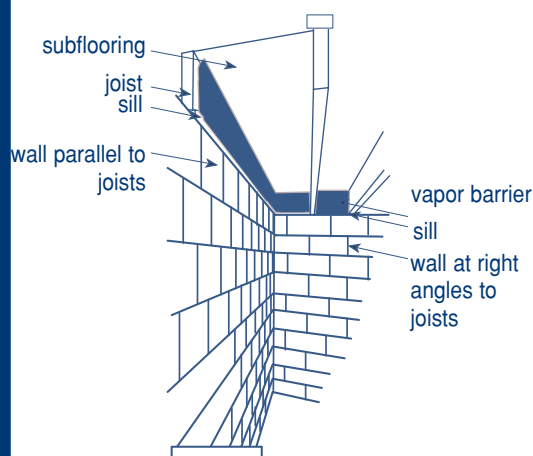

Figure 13: Band joist areas to be insulated.

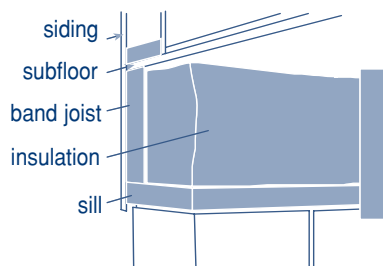

Figure 14: Cut insulation to fit band joist between the sill and subfloor.

Interior Basement Walls (using batts or blankets)

Before beginning, check your local fire code for any special insulation requirements. Insulating the interior of your basement's perimeter walls is usually less expensive and less involved than insulating the outside of the perimeter walls. Though these techniques require some carpentry, they are generally within the means of the average do-it-yourselfer.

How-To Instructions:

Step 1: Correct any extensive water problems before insulating. A continuous layer of 4 mm or 6 mm polyethylene plastic can also be installed against the wall before insulating for additional moisture protection. Install the sheeting by stapling it to the sill and letting it drape down along the wall.

In basements used only for storage:

Step 2: Using nailing strips (½-inch by 1½-inch lumber), nail 24- or 36-inch widths of blanket insulation to the sill or band joist (Figure 15).

Step 3: Cut the insulation so it cascades down the wall onto the floor for approximately 16 inches.

In basements used for living space:

Step 2: You will need to build a stud wall against the masonry to hold the insulation. Begin by measuring the space and figuring the amount of material you will need. You will need:

- 2- by-4 inch lumber for vertical nailers (Figure 16).
- R-11 or R-13 batts or blankets.
- Gypsum wallboard or paneling to cover insulation and frame.

Begin by building a stud wall inside the masonry foundation wall. Studs should be spaced so there's either 16 or 24 inches from the center of one to the next. This is to allow use of standard-width insulating materials.

Step 3: Place 3½-inch thick blanket or batt insulation (R-11 or more) between the studs, making sure that the insulation fits snugly at top and bottom. Also, make sure any attached vapor barrier faces the living area. If you place the stud wall 2 inches away from the masonry wall, you can use R-19 insulation materials.

Step 4: Finish with drywall or paneling fastened to studs.

Interior Perimeter Basement Walls (using rigid insulation panels)

Step 2: Attach 2- by-2-inch nailing strips to the wall and space the vertical strips 24 inches apart to permit efficient use of standard 4- by-8-foot paneling sheets and drywall.

Step 3: Cut panel insulation to fit between nailing strips and top and bottom plates and press it into place.

Step 4: Finish with drywall or paneling fastened to studs.

The Outside Basement Walls

Exterior foundation insulation is usually done during construction. It is a difficult job to perform on a finished house. It requires trenching around the foundation to allow work space. Rigid panel insulation is glued to the exterior wall of the basement. Above the ground level, the insulation is covered with cement board or pressure-treated plywood to protect the insulation and secured to the foundation. The dirt is then replaced around the house.

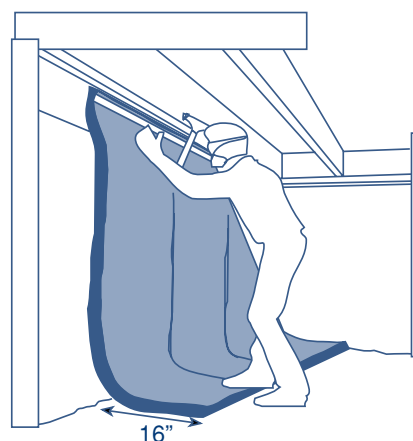

Figure 15: Nail long pieces of insulation to the band joist.

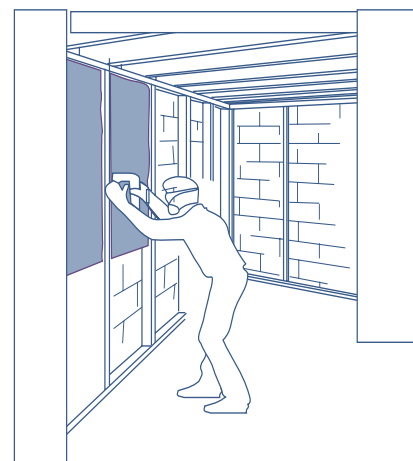

Figure 16: Cut insulation to extend from the top plate to at least 2 feet below ground level.

FLOORS

Floors over unheated areas can be the source of considerable heat loss. Your floors will fall into one or more of the types listed below and should be insulated accordingly.

Floors Over Unheated Spaces

Because your unheated garage, porch or crawl space may get as cold as the outside during winter months, floors above these areas should be insulated to R-19 levels. Make sure that water pipes and ducts are insulated and that the ducts are vapor sealed.

To insulate these areas, follow the instructions below:

How-To Instructions:

Step 1: Purchase R-19 batt or blanket insulation with an attached vapor barrier. Buy the width that best fits the floor-joist spacing and look for insulation labeled “friction fit.” This means the product is slightly wider, a feature that makes installation easier. To secure the insulation in place, use a wire-spring clip or wire mesh (Figure 17).

Step 2: Begin installing insulation at one end of the floor joists and work out, pressing insulation up between the joists. The attached vapor barrier should face up, toward the heated portion of the house. The insulation should be flush with the bottom of the floor.

Step 3: Cut wire and staple or nail it at right angles to the floor joists to hold the insulation in place. Friction alone won't hold insulation in place; it will be necessary to install wire or screen.

Step 4: Insulate heating or air-conditioning ducts and water pipes running through the unheated space.

Step 5: Covering any exposed ground in your crawl space with a 6 mm polyethylene vapor barrier will reduce crawl space moisture. Vents with insulated, weatherstripped covers should also be added to allow proper ventilation. These vents should be open in the summer and closed during the winter if no combustion devices are in the crawl spaces.

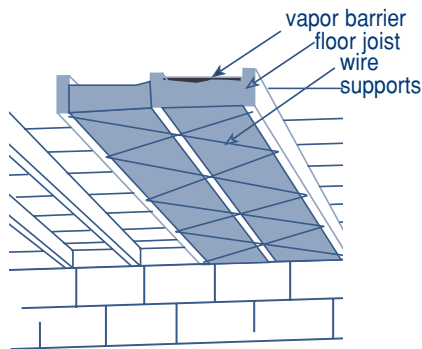

Figure 17: Cut insulation to fit band joist between the sill and subfloor.

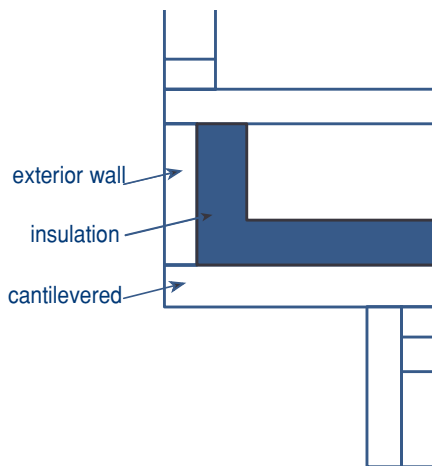

Figure 18: Insulating cantilevered area with batt insulation.

Cantilevered Floors

Cutting heat loss through a floor cantilevered over an exterior wall is just as important as insulating a floor over an unheated basement. These floors are exposed directly to the outside and often have many air leaks, are poorly insulated and are the source of drafts. Depending on how the floor is built, there are a few ways to make cantilevered floors more comfortable. One way is to hire a professional to spray in polyurethane or polyisocyanurate insulation. If you choose to insulate this area yourself, use the following directions:

How-To Instructions

- Step 1:** Determine whether the cantilevered floor adjoins a basement, suspended ceiling or other ceiling type where there is easy access to the space below the floor.
- Step 2:** Caulk and air-seal all cracks, penetrations and air-leakage areas prior to insulation.
- Step 3:** If easy access is found, insert R-19 batt or blanket insulation into the space below the floor. The vapor barrier should face up, toward the heated part of the house.

If easy access isn't found:

- Step 1:** Working from outside the house, remove portions of the siding or other covering from the bottom of the cantilevered floor (Figures 18 and 19).
- Step 2:** Insert R-19 batt or blanket insulation into the space under the floor, or attach rigid foam insulation.
- Step 3:** Replace siding or other materials.

Floor Over an Open Space

A tremendous amount of heat is lost from mobile homes or homes supported by piers above the ground. These floors should be insulated to R-19 or higher.

To insulate these areas, follow the instructions for insulating floors above crawl spaces discussed earlier in this booklet. Some points to note:

- Carefully air seal the floor before insulating.
- Check duct work for disconnections and leaks.
- If batt or blanket insulation is used, cover the insulating materials to protect against moisture, wind and animals.
- Enclose crawl spaces as tightly as possible with vented, insulated skirting.
- Avoid moisture problems by covering the ground below the space with 6 mm polyethylene.

Slab-on-Grade

Slab-on-grade refers to concrete that sits above the frost line where temperatures can quickly become extremely cold. Cold slabs can damage wood and carpets if water and ice condense on the floor.

During construction, rigid board insulation should be installed around its entire perimeter. Though insulation is difficult and expensive to install after your house is built, existing slabs can be insulated using rigid board and plywood flooring installed on top. This type of insulation should be done by a professional.



rigid foam board insulation or spray-in-foam

Figure 19: Insulate under bay windows.

WALLS



Insulating the walls of an existing home is difficult and generally should be done by a professional insulating contractor. Because of the high cost of blowing insulation into exterior walls, this job should be considered only after your home has been thoroughly tightened and the attic and basement/crawl space have been insulated. Generally, those efforts will reward you with significant energy savings and an improved comfort level.

However, if your walls are exposed to cold winds, or if they conduct too much heat out of your home, insulating them may be necessary.

When to Consider Wall Insulation

- Insulating your walls is a good idea when there is less than 1 inch of insulation in the walls. Typically, walls have space for 3½ inches of insulation. If you already have some insulation, the cost of adding more may outweigh the benefits.
- When adding or replacing your home's siding is a good time to consider insulating your walls. Insulation can be blown into empty stud cavities before new siding is installed.
- When doing extensive interior renovation is another good time to consider adding insulation. If you plan to gut the walls of your house for a remodeling project, you definitely should spend the time and money to fill the wall cavities with insulation as long as they're already open.

Determine Level of Insulation

Generally, homes built in the mid-1950s and earlier do not have insulated walls. There are a few ways to determine whether your walls have insulation.

- Turn off the electricity and remove an electrical outlet switch plate on an exterior wall. Using a flashlight, you can look behind it for insulation.
- Remove a section of baseboard molding or paneling to expose an exterior wall cavity and check for insulation.
- Cut a hole in the wall of a closet or cabinet that faces an outside wall. If you find insulation, use a bamboo skewer or other non-metallic device to determine its thickness.

Adding Insulation

If you decide to insulate your walls, obtain bids from several contractors and compare the R-values provided, as well as the cost to

complete the job. Walls should be insulated to a level of R-13 or more. The recommended method to insulate is to use loose-fill insulation or spray-in insulation. It can be blown in through holes drilled into walls. This can be done from inside or outside your home and is best done by an insulation contractor. Blowing insulation in from the interior can be less expensive, but may be messy.

AIR DUCTS



If the ducts for your heating and cooling system run exposed through your unheated attic, garage, crawl space or basement, they should be sealed and insulated (Figure 20).

Getting Started

Here's a list of the materials you'll need:

- Latex-based mastic or mastic tape.
- Duct insulation. It comes in blankets 1 or 2-inches thick. Get the thicker variety, especially if your ducts are in the attic.
- Metal tape.

Step 1: Before insulating, check the ducts for leaks. Leaky ducts can raise a typical home's heating and cooling costs by as much as 30%. The loss can be even higher in homes with uninsulated ducts. Seal the leaks with latex-based mastic tape. Despite its name, duct tape will harden and crack after prolonged exposure to the duct's high temperature. Remove all the old duct tape. Seal all junctions and connections with mastic or mastic tape.

Step 2: Wrap the ducts with foil-faced fiberglass insulation. Make sure the foil backing faces out, away from the duct. Tape the insulation and any exposed fiberglass with metal tape.

Step 3: Seal return ducts, too, so you won't be breathing crawlspace air.

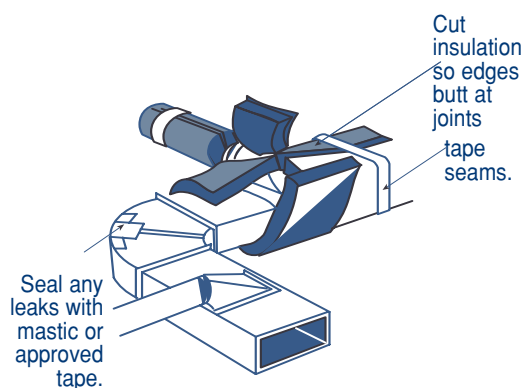

Figure 20: Re-tighten and seal leaky ducts before insulating with foil-faced batts. Tape seams with mastic tape.

APPENDIX



AREA TABLE

Area-To-Be-Insulated Worksheet

Level	_____	x	_____	=	_____
Ceiling (Attic Floor)	length		width		area to be insulated
Exterior	_____	x	_____	=	_____
Walls	perimeter (distance around)		height		area to be insulated*
Basement	_____	x	_____	=	_____
Walls	perimeter (distance around)		height		area to be insulated*
Floor over	_____	x	_____	=	_____
Cold Space	length		width		area to be insulated

* Does not include band joist area.

RESOURCES



- Consumer Guide to Home Energy Savings*, Alex Wilson and John Morrill, American Council for an Energy Efficient Economy, Berkeley, California, 1995.
- Energy Answers Guidebook*, Bangor Hydro-Electric Company, Bangor, Maine, October 1989.
- Home Insulation Guide*, Iowa Energy Policy Council, Ames, Iowa, 1985.
- Home Energy Audits*, Advanced Sciences, Inc., U.S. Department of Energy, Silver Springs, Maryland, March 1989.
- Home Energy Checklist: Energy Factsheet*, U.S. Department of Energy, grant number DE-F847-80CS69097.
- Insulation Factsheet*, U.S. Department of Energy, Office of Scientific and Technical Information, Oak Ridge, Tennessee, January 1988.
- Residential Heat Loss*, Fred C. Vosper and Barbara J. Wiersma, Cold Climate Housing Information Center, University of Minnesota, St. Paul, Minnesota, 1988.
- Taping Foam Sheathing for Energy Performance and Moisture Control*, Energy Design Update, Vol. 15, No. 9, Cutter Information Corp., New York, NY, September 1995.

This is an Iowa Energy Center publication.



2521 ELWOOD DRIVE, SUITE 124
AMES, IOWA 50010-8263
515-294-8819 • FAX 515-294-9912

This publication has been updated and modified for use in Arkansas by the Arkansas Department of Economic Development – Energy Unit.



ONE CAPITOL MALL
LITTLE ROCK, AR 72201
501-682-7319 • FAX 501-682-2703
WWW.1800ARKANSAS.COM/ENERGY/

This publication is distributed by:



ARKANSAS

Arkansas Department of
Economic Development
Energy Unit
One Capitol Mall
Little Rock, AR 72201

