

HOME TIGHTENING



Caulking and Weatherstripping Your Home to Save Money and Energy

INSIDE

GET TIGHT AND SAVE	2
AIR LEAK CHECKLIST	4
CAULKING REFERENCE GUIDE	7
WEATHERSTRIPPING REFERENCE GUIDE	11
MORE IDEAS AND DETAILS	12

GET TIGHT AND SAVE

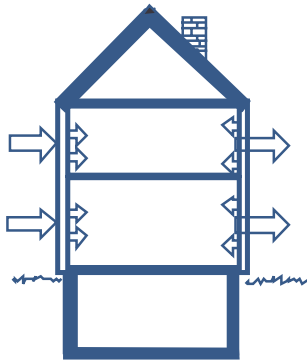

Figure 1: Wind-driven infiltration.

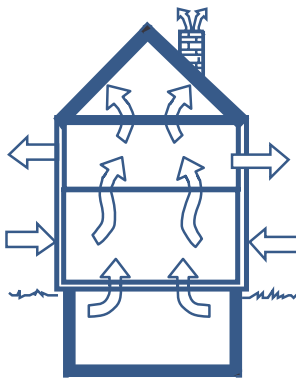

Figure 2: "Chimney-effect" infiltration.

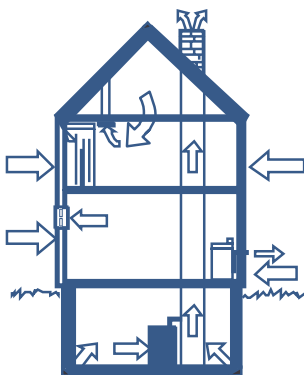

Figure 3: Negative air pressure.

The High Cost of Leaky Homes

Air leaks through the ceiling, walls, foundation and other areas typically account for the greatest home-energy costs. According to the American Council for an Energy Efficient Economy, each year in the U.S., nearly \$13 billion worth of energy — in the form of heated or cooled air — escapes through holes and cracks in residential buildings. That's an average of \$150 per household each year. If your house isn't properly sealed against air leaks and infiltration, you're paying the price. Tightening up your home can cut this waste and save you up to 40% each year on heating and cooling costs.

Protect Your Investment

Most people think they should caulk the outside of the home to protect it from the elements. This is true, but it is equally important to prevent conditioned air from escaping to the outside through interior air leaks. Moist interior air enters the walls and ceiling through cracks and holes. Condensation can build up in the walls, damaging or destroying the insulation, wiring, wood and other building materials. Given the variations in Arkansas' temperature and humidity, adequate weatherproofing is crucial in preventing expensive problems such as warping, burst pipes or frost damage to the foundation. Ideally, your home should last for years and require only routine maintenance. Caulk and weatherstripping don't cost much and for a single afternoon's work, you can save both money and extend the life of your home.

Air and Air Leaks

Every home needs a certain amount of fresh air for such things as: the furnace and appliances that burn fuel, to get rid of excess moisture and to reduce odors and stuffiness. When this air exchange is controlled, we call it *ventilation*. However, a great deal of air exchange occurs in uncontrolled and invisible ways — through hidden cracks and openings present in every house. This is called *infiltration*.

Infiltration occurs when wind blows cold air into the house and forces hot air out. It also happens during the natural process of convection as warm air rises and escapes through cracks, causing cold air to be pulled into the lower portion of the house. This is known as the "chimney effect." (Figure 2) In addition, when appliances that burn fuel use up air, or when ventilation fans exhaust air, negative air pressure

(Figure 3) is created in a house. Consequently, cold air enters through any available openings to equalize that pressure.

Tightening Is The First Step

Infiltration causes drafts which contribute to heating and cooling expenses, discomfort and, in some cases, illness. Raising your thermostat will not stop cold drafts, but sealing hidden cracks and openings will. By stopping drafts at their source, you can be warmer at lower thermostat settings and use less fuel and money. Fortunately, infiltration is one of the easiest forms of heat loss to correct if you know what to look for. It only requires a careful inspection of your home, some inexpensive weatherstripping, caulk, filler materials and time. **Tightening up your home is the first step you should take in cutting your energy costs.** The second step is to *insulate* your home. Information on home insulation is covered in a separate *Home Series* booklet.

MAKE A PLAN

Your first step should be to perform a detailed inspection of your home for air leaks. You can either try to do this yourself or hire a professional energy auditor to identify where heat loss is occurring in your home and how to stop it. Before you hire an energy auditor, check your local yellow pages and look for a contractor or energy specialist who offers an energy audit as part of his or her service.

A good energy audit will include a *blower door test*. A blower door is a large fan that fits tightly into an exterior doorway in your home. It depressurizes the space inside your home, which then causes air to flow in through the cracks. The energy auditor then can walk around and tell you where the leaks are by feeling for air flow by hand or by using a “smoke pencil” and noting where the smoke is affected by incoming air leaks.

Once you’ve located the air leaks in your home, you are ready to start plugging them. You will realize the greatest savings by plugging the biggest holes and leaks first. These large leaks are often tucked away in unlikely spots: a chimney with an open or missing damper, around the drain under the bathtub, around vent pipe openings, etc. A good rule of thumb is to “seal the high and low air leaks first.” First, check around your home’s attic floor and crawl space or basement walls, especially around the sillplate and band joist where the floor sits on the foundation and air can leak in around the framing. The “Air Leak Checklist” will help you identify likely places to find air leaks.

Ventilation Safety Tips

- Two important areas to ventilate properly are attics and crawl spaces. Good attic ventilation is especially important. Without it, any moisture penetrating a ceiling becomes trapped in the attic.
- Provide cross ventilation areas to circulate air through the attic. Vents high, near the top of the roof, and low, at the lower edge, let air circulate naturally. See *Home Series* issue on *Insulation* for specifics on attic and crawl space ventilation.
- Good ventilation also reduces heat buildup in the summer.
- Generally speaking, while it is hard to get an older home “too tight” you should make sure you have adequate ventilation in your home. Some signs that you do not have enough ventilation include lingering odors, stuffiness and condensation on windows and walls.
- Under certain extreme conditions, tightening up a home may cause back drafting of natural gas or propane furnaces and water heaters.
- Regularly maintain and test gas appliances.
- Install a carbon monoxide detector in your home.

Some signs of carbon monoxide exposure are:

- Entire family is sick at the same time with flu-like symptoms
- Flu-like symptoms decrease while away from the house
- Illness is present when gas appliances are in use

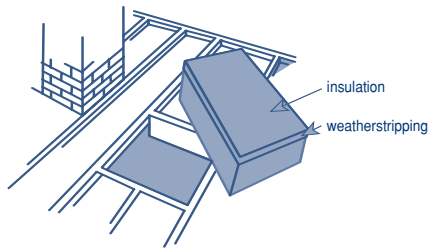

Figure 4: If you have an attic hatch, make sure it fits tightly. Do this by weatherstripping the edges of the hatch and insulating the backside of the door with two or more inches thick of foam insulation.

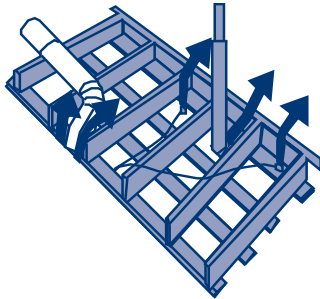

Figure 5: Recessed lights, wiring, pipes and other openings in insulated ceilings can result in a tremendous amount of heat loss.

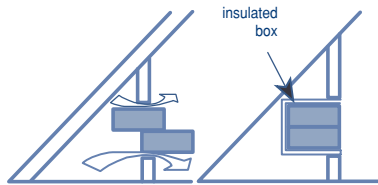

Figure 6: Enclosed storage drawers in the attic should be sealed to prevent air leaks.

THE AIR LEAK CHECKLIST

The Attic

❑ *Doors and Hatches to the Attic*

Weatherstrip the edges and insulate the back side of the attic door. Fold-down stairs can be covered with a lightweight box made of rigid insulation, (Figure 4).

❑ *Holes in Attic Floors*

Seal all holes in the attic floor. These include openings for wires, pipes and vents, (Figure 5). Seal these areas with a good, general-purpose caulk. Filler material may be needed for larger holes.

❑ *Plumbing Stack(s)*

This channel may run inside the walls of your home, from the basement to the attic, with openings at each floor where the pipes branch off. Use the piping runs in the basement to help you locate holes. Plug the bottom and top of the chase with foam caulk or 6-mil polyethylene.

❑ *Exterior and Partition Wall Tops*

Caulk along the tops of interior walls where the top plate meets the plaster or drywall.

❑ *Attic Knee Walls/Storage Drawers*

If storage drawers are recessed into the attic space, an airtight, insulated box should be built around the back side of the drawers, (Figure 6).

❑ *Other Holes*

Seal all other holes between the heated space in your house and the attic.

The Basement

❑ *Ducts*

In homes with forced air heat there may be large cracks or gaps where the ducts pass through the ceilings, floors and walls. Caulk between the metal duct opening and the ceiling, floor or wall it is mounted to.

❑ *Basement Windows*

Using a caulk that works well with masonry, fill any cracks where the frames of the windows are set into the walls. Windows that are not used for summer ventilation or as fire exits can be permanently caulked shut.

❑ **Sill Plate and Band Joist**

Fill any crack between the sill plate and foundation wall using a caulk that works well with masonry. Use a wood caulk to fill any cracks between the sill plate and band joist. Then insulate the band joist area, (Figures 7 and 8).

❑ **Openings Through Basement Ceiling**

Seal the hole where the bath tub drain comes down and any other holes for plumbing or electrical wiring in the basement ceiling with caulk or foam. Filler material may be needed for larger holes.

❑ **Other Holes**

Seal any holes or cracks in the foundation of your house with caulk or foam.

The Main Level

❑ **Electrical Outlets**

Install foam gaskets on all outlets and switches, even on interior walls, and use child safety plugs backed with punch-outs to keep the cold air from coming through the sockets. Remember, be careful whenever working around electricity, (Figure 9).

❑ **Air Conditioners**

If you have a room air conditioner, remove it for the winter or seal it up and insulate it. Water heater insulation jackets can work well for covering and insulating the air conditioner.

❑ **Windows and Doors**

Weatherstrip and caulk all cracks between the wall and the window trim, especially under the window sills. Replace broken glass and putty any loose window panes. Caulk around the moving parts of windows with rope caulk (see page 7) during the winter. This type caulk can be easily removed in the spring.

❑ **Missing Plaster**

Exposed laths indicate a direct hole into wall and ceiling cavities. Repair with plaster or cover with new sheetrock.

❑ **Recessed Lights and Bathroom Fans**

These fixtures can poke into the attic insulation and create a pathway for air leaks. Caulk around them from below with high-temperature flexible caulk or replace the older recessed light fixtures with newer ones that are IC (insulation contact) and AT (air tight).

❑ **Window and Door Frames, Trim and Baseboards**

Caulk around the windows and exterior door frames. Also caulk along the trim and baseboards with an interior grade caulk. A clear drying or paintable caulk is best for this job.

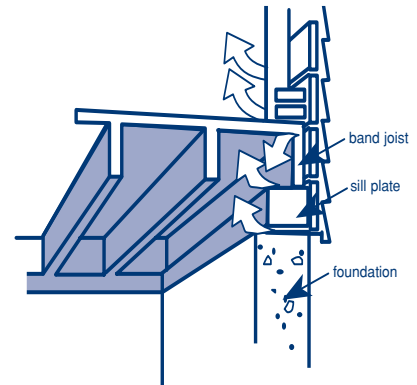

Figure 7: Get rid of drafts along the floor by caulking along the sill plate and band joist in the basement.

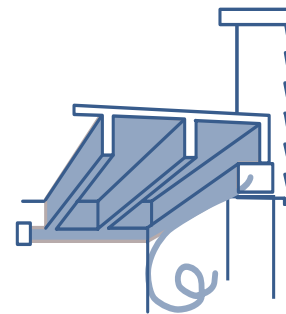

Figure 8: Backer rod or crack filler can also be used for sealing deep cracks or as a backing for caulk.

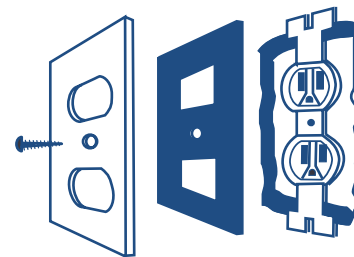

Figure 9: Outlet gaskets are installed between the electrical outlet and the coverplate. Plastic plug inserts will also prevent air from entering your home.

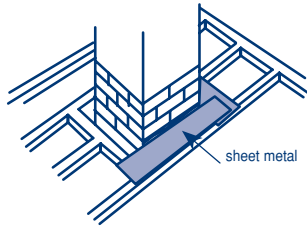

Figure 10: A tremendous amount of heat can escape around the chimney if it isn't properly sealed.

❑ *Other Exterior Wall Holes*

Seal around all ceiling fixtures, heat registers, medicine cabinets, bathtubs, kitchen cabinets, drains and water pipes where they enter the wall in the kitchen and bath and any other holes in exterior walls.

❑ *Around the Chimney*

Any gap that runs vertically the height of the house around the chimney should be sealed at both the basement ceiling and attic floor levels. Seal these gaps using 26-gauge sheet metal, (Figure 10).

Fireplace Damper

❑ *Fireplace Dampers*

Fireplaces are inefficient heating systems. The most effective fireplace treatment is to air-seal the chimney with a “plug,” (see page 12). If the fireplace is used, make sure that the damper fits tightly preventing conditioned air from going up the stack. If needed, install a new damper or repair the existing one so it closes tightly.

Outside

❑ *Openings to Exterior*

Caulk around openings for electric, gas, oil and water supply lines, drainage pipes, plumbing for outside spigots, cable TV and telephone cables. Dryer vents, mechanical ventilation system vents and combustion air supply vents for furnaces should also be sealed, (Figure 11).

❑ *Window and Doors*

Caulk around window and door frames. If you have combination storm windows, caulk around the windows where the metal meets the window's frame. If you have wooden storm windows that must be exchanged for screens in the summer, use rope caulk to seal around them. Install storm doors where you have none.

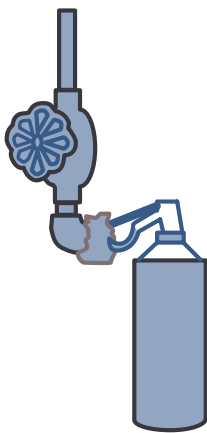

Figure 11: Expanding foam sealant works well for sealing gaps over 1/4" wide.

CAULKING



What Is Caulk and Where Do You Use It?

Caulk is basically a rubber-like paste that sticks to a variety of surfaces and stays flexible after drying. Caulk is used wherever a permanent seal is desired, such as cracks and gaps between window frames and siding.

Most types of caulk are sold in tubes that fit a caulking gun (Figure 13), though some types come in cans and are applied with a putty knife. There are many types of caulk on the market, so you should be able to find one that meets your specific needs. Make sure the type of caulk you choose works on the materials you wish to seal. Table A provides descriptions of common caulking compounds and their uses.

Filler Materials

In addition to the types of caulk described in Table A, there are fillers, such as cotton, foam and sponge rubber, that are used to fill extra-wide gaps. There is also rope caulk, which comes in rolls or strips.

Rope Caulk

Rope caulk is a gray, putty-like material that comes in long strips or rolls and can either be round or flat. It is easy to work with, remains flexible, and can be removed when the weather turns warm. Rope caulk should be used for windows and other places you'll want to be able to open up again come summertime. Note that rope caulk will not last longer than a year.

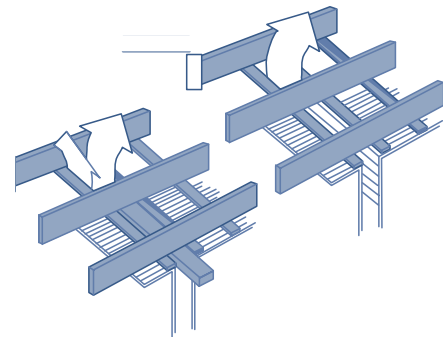

Figure 12: Depending on the way your house was framed, a lot of warm air can escape into the attic through the partition walls. Seal from the attic.

For the best advice and results, contact or visit your local hardware or building supply store. Ask for help on choosing the best product for your air-tightening project.

The following air-tightening products are a sample of those available:

TABLE A: COMMON CAULKING MATERIALS AND USES

Compound	Cost	Elasticity	Adhesion	Comment
Acrylic	Low-Moderate	Very Good	Most surfaces	Hard to apply/clean; exterior use only due to noxious odor.
Copolymers	Moderate-High	Very Good	Good except to plastic surfaces	Fairly easy to apply; durable; interior/exterior use.
Polyurethane	Moderate-High	Very Good	Most surfaces may need primer	Relatively easy to apply; solvent cleanup; unpleasant odor; paintable; interior/exterior use; deteriorates in sun.
Silicone	Moderate	Excellent	Almost all surfaces, good bonding to wet surfaces	Easy to apply; interior/exterior use; can be painted; high moisture resistance; exceptional durability and long life.
Acrylic	Expensive	Very Good	Most surfaces, except concrete	Very durable; not all types can be painted; shrinks little; general all-purpose caulk.

Source: U.S. Dept. of Energy, *Energy Efficiency and Renewable Energy Clearinghouse*, publication DOE/CE0253, 3rd ed., April 1992.



Other Ways to Save

- Maintaining the thermostat at 78° F in the summer and 65° to 70° F in the winter is a home energy-saving step that costs nothing and will cut your heating and cooling bills.
- In the winter, lower your thermostat even further at night and when you're away from home.
- Turning the thermostat down eight degrees for at least eight hours will save about 8% to 10% on your home heating costs — about 1% for each degree set back.
- These measures are important for reducing the energy costs of your home, but you won't enjoy your full savings potential until you find and plug the air leaks.

Expanding Foam

Different insulating foam products have different expansion capabilities and uses. Low to minimal expansion foam is useful for sealing areas around newly installed windows and doors because it does not interfere with their operation. Use maximum expanding foam for large cracks near non-moving parts of the home.

Filling Large Gaps

Foil-Ray™, Reflectix™ or other foil-faced bubble wrap is ideal for sealing gaps too wide for foam. For really large holes, cut sections of rigid foam insulation to fit and glue into place with expanding foam.

How To Caulk

Generally, it is much easier and more effective to seal leaks from the inside of the house than from the outside. Interior sealing prevents warm, moist air from getting into the walls where it can cause damage. Caulk around openings for such things as electric, gas and waterlines and outside cracks that will allow wind-driven water to enter. This includes the areas where window or door frames meet the exterior siding.

To apply caulk, you'll need a few simple tools: an inexpensive caulking gun, caulk tubes, filler materials for wide gaps and a large screwdriver or putty knife for smoothing and digging out old caulking. You may need to use a ladder to reach some of the areas that require caulking. Carry your caulking gun on a simple sling so that you can use both hands while climbing.

Before you buy your materials, you need to decide what type of caulk to use. The information in Table A will help you choose the caulking material best suited for your job. Next, you need to determine the number of tubes you will need. This may be difficult, since the number of tubes will vary with the size and number of cracks to be filled. One tube is usually sufficient to caulk around two doors or windows. Six should be enough to start the job, and you can always buy more tubes as you need them.

Do not apply caulk in cold weather. The minimum temperature for good adhesion is usually around 40° F, so it's best not to put off the job until winter. The caulk manufacturers' directions will also have specific temperature recommendations for using their products. Low humidity is also important, so the cracks aren't swollen shut with moisture. Make sure the area you are working on is clean and dry. Remove all built-up paint, dirt and old caulk with your screwdriver or putty knife before applying any new caulk. Larger cracks and seams will require filler material before adding the caulk.

It takes practice to draw a good "bead" of caulk, and your first attempts may be a little messy. Start in an inconspicuous location and

have a rag ready to clean up mistakes. While it's important to read the caulk manufacturer's instructions before you start, here are some general tips:

- Cut off the tip of the cartridge nozzle at a 45° angle, keeping in mind that the more nozzle you cut off, the larger the bead will be, (Figure 13).
- When applying the caulk, hold the gun at a 45° angle.
- Caulk completely around doors, windows and fixtures. Use filler material first in large cracks and openings, and then try to seal them shut with caulking in one continuous movement. Stops and starts may leave gaps for air and moisture to enter.
- Make sure the bead is wide enough to overlap and adhere to both sides of the opening. Ideally the bead should be between ¼-inch and ⅜-inch wide.
- If necessary, smooth the caulk with a putty knife or your finger, taking care not to press it too thin where it adheres to the sides. If the caulk is too thin at the sides of the bead, it will shrink and curl back, reopening the gap.

The caulk should both stick to the surface and remain flexible enough to withstand the normal contraction and expansion of your house. Caulk used on the outside of your house should be more durable than that used inside because it is constantly exposed to the elements.

Once you have applied the caulk, it takes time for it to dry, or *cure*. Curing time is reported two ways. The *tack-free time* tells you how quickly the fresh caulk's outer surface will dry, or skin over. Once the caulk has skinned over, it will not pick up dirt and dust, and in most cases can be painted. Consult the cartridge label, though, before painting over the caulk. Some products such as silicone cannot be painted. The *total cure time* indicates the time required for the caulk to become completely stable, or reach the point where no further drying or shrinking will occur.

Safety Issues

Most caulking compounds pose no known health hazards after they are fully cured. However, most caulks give off solvent fumes while they are curing, so adequate ventilation is needed for indoor caulking projects. As Table A indicates, some high-performance caulking compounds contain irritating or potentially toxic ingredients, and should therefore only be used outdoors. Never use lead-based caulking compounds, as they are highly toxic. Many states have already banned their use. Carefully read the manufacturer's instructions and take the appropriate precautions to ensure that pets and small children do not come into contact with the fresh caulk.

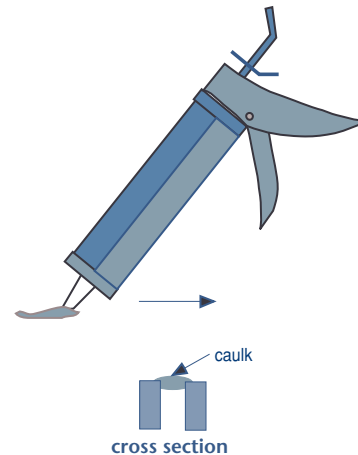

Figure 13: Hold caulking gun at 45° angle, and make sure the bead of caulk is wide enough to overlap and adhere to both sides of the opening.

WEATHERSTRIPPING

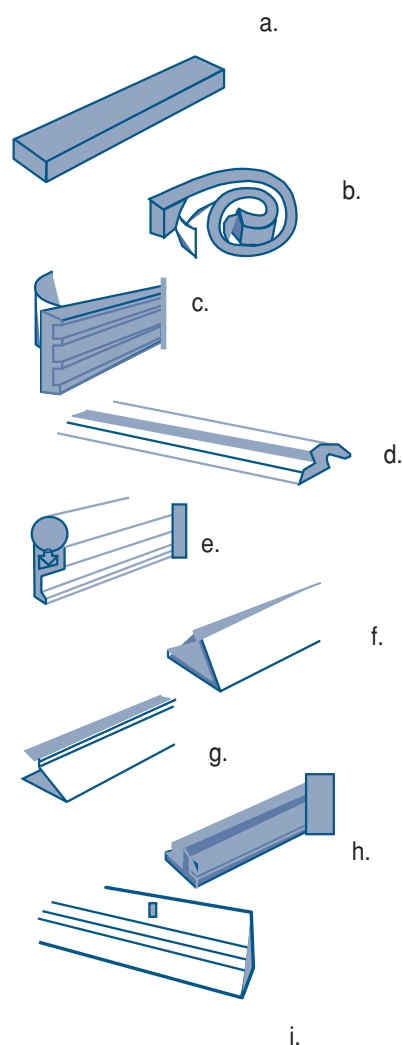

Figure 14: Weatherstripping types (top to bottom):

- a. non-reinforced felt,
- b. non-reinforced self-adhesive sponge rubber,
- c and d. reinforced vinyl foam and felt,
- e. rolled vinyl with rigid metal backing,
- f. spring plastic (vinyl),
- g. thin spring metal,
- h. fin seal,
- i. door sweep (vinyl lip with metal, wood or plastic retainer).

While caulking is used to make a permanent seal between two stationary surfaces, weatherstripping is used to make a seal where one or both of the surfaces must be free to move, such as a door or a sliding window. Weatherstripping is basically a narrow piece of metal, vinyl, rubber, felt or foam that prevents air infiltration around windows and doors by sealing the gaps between the frames and moving parts when they are closed. All of your home's exterior doors should be weatherstripped, along with any doors that lead to unheated areas, such as the attic, garage or basement. All operable windows should also be weatherstripped.

Weatherstripping can be purchased by the foot or in kits at your local hardware or building supply store. Before you buy anything, you should determine what kind of weatherstripping you want to use, based on the strengths and weaknesses of the materials and where it will be used. Table B provides information about the most common weatherstripping materials on the market. The size of the gap between the fixed and moveable sections, as well as the amount of expected wear and tear, may help you to decide which material is the most appropriate. You can calculate the amount of weatherstripping you'll need by measuring the perimeters of all of the windows and doors to be weatherstripped. It's a good idea to add 5% to 10% more for waste.

Keep in mind that less-durable materials will have to be replaced more frequently. Doors and windows should be weatherstripped all the way around their outer edges, and it's best to apply one continuous strip along each edge, or joint, making sure the stripping is tight at the corners. Extra-durable stripping should be used along the bottoms of doors, since this area will receive the most wear and tear.

Installing

Before you begin installing the weatherstripping materials, assemble all your tools. The following basic hand tools should be all you'll need for a complete weatherstripping job:

- Measuring tape
- Tin snips or heavy-duty scissors
- Screwdriver
- Hammer
- Appropriate nails or screws

Continued on Page 12

For the best advice and results, contact or visit your local hardware or building supply store. Ask for help on choosing the best product for your weatherstripping project.

The following weatherstripping products are a sample of those available:

TABLE B: WEATHERSTRIPPING MATERIALS AND USES

Material	Cost	Where used	Comments
Non-reinforced Felt	Low	Window & door stops on top or bottom, attic hatches	Very easy to install, but tears easily. Use where little wear is expected; must be glued or nailed in place; visible.
Adhesive-Backed Foam Rubber	Low	Best as door stops around top, sides & bottom, attic hatches & non-operable windows	Easy to install; not durable; use where little wear is expected; can reinforce with staples; visible.
Foam Rubber with Backing	Low-moderate	Door frames, window tops & bottoms, attic hatches	Wood or metal backing; must be nailed in place; not very durable; visible.
Reinforced Vinyl, Foam & Felt	Low-moderate	Door frames, window tops & bottoms, attic hatches	Moderately durable; nail in place; visible.
Rolled Vinyl with Metal Backing	Moderate-high	Top & sides of door on casings	Easy to install; nail in place; can pull away from backing in cold weather; visible.
Spring Plastic (vinyl)	Moderate-high	Top & sides of doors, double-hung & sliding window channels	Very effective, but surfaces must be flat & smooth; durable; easy to install; invisible when in place.
Magnetic	High	Top & sides of doors, double-hung & sliding window channels	Very effective air sealer, similar to refrigerator gaskets.
Thin Spring Metal	High	Top & sides of doors, double-hung & sliding window channels	Durable and very effective, but surfaces must be flat & smooth; easy to install; invisible when in place.
Fin Seal	Moderate	Used with aluminum sliding windows and sliding glass doors	Brushlike; very durable; can be difficult to install.
Door Sweeps	Moderate-high	Bottom of doors; useful for flat, smooth thresholds	Fairly easy to install; visible; can snag on indoor carpet. Brush vinyl and other options available.
Vinyl Bulb Thresholds	Moderate-high	Under bottom of closed doors; useful with worn wooden or no thresholds	Durable; door must be removed for installation.
Interlocking Metal Channels	High	Bottom, top & sides of doors	Very difficult to install, should be done by professional; exceptional weather seal; durable; alignment is critical.

Source: U.S. Dept. of Energy, Energy Efficiency and Renewable Energy Clearinghouse, publication DOE/CE0253, 3rd ed., April 1992.

Thin spring metal and weatherstripping with metal backing requires tin snips or heavy-duty scissors for cutting. You should measure the areas to be stripped at least twice before you cut any of the weatherstripping to size. This will help eliminate mistakes and the added expense of wasted materials. It's also a good idea to test fit strips against door and window sills before nailing or gluing them in place. The weatherstripping must fit snugly against both surfaces and be slightly compressed (when doors and windows are in the closed position) to be effective. If the stripping is held in place by nails or screws, space them 10 to 12 inches apart. Stripping with metal backing often has pre-drilled holes for the nails.

A FEW MORE IDEAS AND DETAILS



Roofs and Exterior Walls

In addition to the weatherproofing methods and features mentioned earlier, the roof and exterior paint also protect your house and help maintain a fairly moisture-free environment inside. Cracked or peeling paint allows moisture to penetrate the building materials of your home, and may eventually give rise to air leaks. Keep your house protected by repainting or touching up paint whenever necessary. Similarly, inspect your roof for leaks. Water leaks will damage your home's insulation and structural materials and can become a very expensive problem if ignored.

Fireplaces

While fireplaces may seem warm and cheery, they often lose more heat than they give off. Warm air in a home is sucked up the chimney and is replaced by cold air leaking into the house. Consequently, most fireplaces operate at a total efficiency between -10% to +10%. In other words, some fireplaces lose 10% more heat than they give. Here are some tips to improve the efficiency of your fireplace.

- **Plug your fireplace.** If you never use the fireplace, put a plug in the flue of the chimney to reduce heat loss. Seal the plug to the chimney with caulk and be sure to tell anyone who may want to start a fire that the chimney is plugged. If you occasionally use the fireplace, you can make a tight-fitting plug for the fireplace opening with rigid board insulation, plywood with pipe insulation around the edge or an inflatable DraftStopper™.

- **Improve the seal of the flue damper.** To test the damper's seal, close the flue, light a small piece of paper and watch the smoke. If the smoke goes up the flue, there's an air leak. Seal around the damper assembly with refractory cement, but don't seal the damper closed. If the damper has warped from high heat over the years, get a sheet metal shop to make you a new one.
- **Install tight-fitting glass doors.** If your fireplace is designed to bring in outside air for combustion, then a tight-fitting glass door will prevent inside air from being used for combustion.
- **Caulk around the fireplace and hearth.** Do this where they meet the structure of the house, using a butyl rubber caulk.
- **Use cast-iron firebacks.** They are available in a variety of patterns and sizes, and improve fireplace efficiency by reflecting much of the fire's radiant heat into the room.
- **Locate the screen slightly away from the opening.** This allows the heated air to flow over the top of the screen. While preventing sparks, fire screens can also prevent as much as 30% of the heat from entering the room.

Doors

Exterior doors receive constant use and are exposed to the elements. While they are not the greatest source of heat loss in a home, they can be an energy waster if they don't work properly.

All doors between heated and unheated spaces should be tested to make sure they fit tightly. Common problems include door dragging, gaps around the edges and underneath the door and loose latch and knob assembly. Door dragging can be fixed by repairing or replacing hinges. All gaps and spaces around and under the door that are not corrected by fixing the hinges should be weatherstripped for a tight seal. Most types of weatherstripping for doors can be installed by an inexperienced person with the tools mentioned earlier. Door sweeps help to seal cracks at the bottom of the door. Door knob and latch sets are relatively inexpensive and are a good investment if your present latch works poorly.

There are several types of weatherstripping for doors, each with its own degree of effectiveness, durability and level of installation difficulty. For the most part, door weatherstripping is easy to install, even for the novice. See Table B for some weatherstripping options, and consult with the salesperson at your local hardware or building products store about the weatherstripping material that is most appropriate for your project. In general, a single type of weatherstripping material is used for the top and sides of a door, while a different, more durable material is used to line the bottom edge.

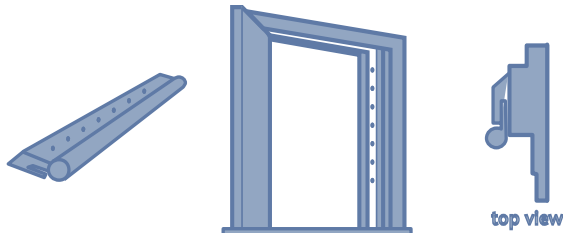

Figure 15: Rolled vinyl stripping with a metal backing.

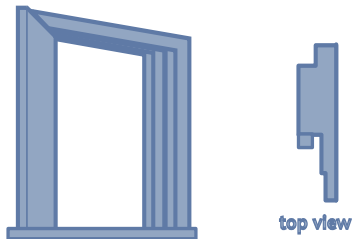

Figure 16: Adhesive-backed foam rubber strips.

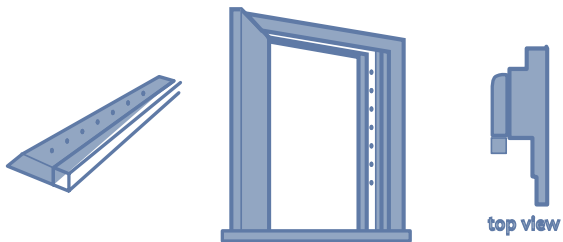

Figure 17: Foam rubber with wood backing.

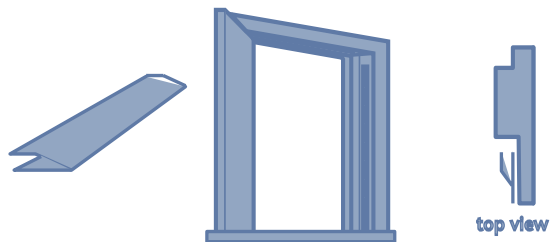

Figure 18: Thin spring metal.

Top and Sides

- **Rolled vinyl stripping** with a metal backing should be tacked to the edge of the door jamb so that the vinyl faces the door and is slightly compressed when the door is closed. Use tin snips to cut the strips to size, and be careful not to leave gaps at the corners. At corner points, the strip ends can be cut at 45° angles and joined together. If pre-drilled tack holes aren't provided, space the nails or tacks six inches apart, (Figure 15).
- If you're using **adhesive-backed foam rubber** strips, measure the tops and sides of your doors to find out how much you should buy. It generally comes in rolls. Cut the strips to size and stick them to the inside face of the jamb, making sure not to leave any gaps at the corners where air could enter, (Figure 16).
- **Foam rubber with a wood backing** should be positioned so that the foam fits snugly against the door when it's closed, (Figure 17).
- **Thin spring metal** should be tacked in place along the inside edge of the door jamb. Use a screwdriver to pry back the outer edge of the stripping so that it fits tightly against the door edge when it's closed, (Figure 18).
- **Interlocking metal channels** installed on both the door and door jamb make extremely effective weatherseals. They're very difficult to install, however, and it may be a good idea to have them installed by a professional carpenter.

Bottom Edge and Threshold

- **Sweeps** are useful for stopping air leaks under doors with flat thresholds, (Figure 19). Sweeps are metal strips with rubber or vinyl extensions, though some have "brush" extensions. While they're easy to install, they may catch on carpeting or rugs. Remove the door from its hinges and measure the bottom edge with a tape measure. If the sweep isn't pre-sized, cut it to fit 1/6 of an inch in from the edges of the door. Some sweeps are made to fit the inside edge of the door, while others fit the outside edge, so be sure to check the manufacturer's instructions before installation.
- **Door shoes** are good for worn down wooden thresholds. Basically they're metal tracks with a rounded vinyl strip that makes contact with the threshold when the door is closed. They're a bit harder to install, because the door must be removed and the bottom edge trimmed or planed down to allow sufficient clearance. After measuring the

door width, slide the vinyl out of the metal track and secure it to the bottom edge with wood screws, (Figure 20).

- **Vinyl bulb thresholds** are similar to door shoes, but they are installed under the door in place of the threshold, instead of to the bottom edge of the door. Again, the door must be removed and trimmed for installation. In addition, the bottom edge of the door must be beveled $\frac{1}{8}$ of an inch so the door can close easily, (Figure 21) Vinyl thresholds wear out, but can be easily replaced.

Storm doors

Storm doors will not solve heat loss problems or be cost effective without first weatherproofing the primary doors. If your primary exterior doors are made of hollow-core wood, they may be responsible for a great deal of heat loss and heat gain. The addition of storm doors is a relatively inexpensive way to correct the problem. Combination (window and screen) storm doors are designed for installation over exterior doors and can greatly reduce drafts. They are available at most building supply stores and can be professionally installed, though you can save a few dollars and do it yourself. In either case, weatherstrip the primary door before installing the outer door for maximum protection against heat loss and cold-air leaks.

A slightly more expensive option is to replace your exterior wood doors with insulated foam core doors, which are often made of steel or aluminum.

Windows

Windows lose more energy per square foot than any other element in a home. The poor insulating properties of the standard single-pane window provide ample opportunity for air leaks and heat loss. Any unsealed crack around the trim where the window fits into the house can cause unwanted air to enter. Older windows often have sashes that no longer fit properly, frames that are out of square due to the house settling, deteriorating wood, excessive paint build-up, broken sash locks, and broken or missing counterweight ropes and pulleys. Cracked or missing panes also add to heat loss.

Before starting a window weatherstripping project, examine the window sashes (the parts that move) to make sure they are sound enough to hold the small nails or screws used to secure the weatherstripping. If they are badly damaged or rotted, consider replacing the entire window unit. Many lumberyards and window dealers provide free estimates for replacing windows.

Window Types

There are several types of windows commonly found in Arkansas homes. **Fixed, or picture, windows** are permanently sealed in their frames and cannot be opened, (Figure 22). For this reason, they do not need to be weatherstripped. However, check the seal around the glass.

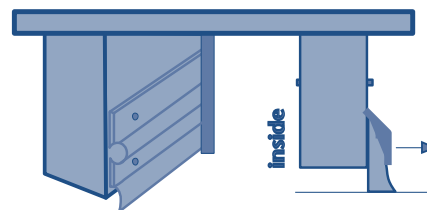

Figure 19: Door sweep.

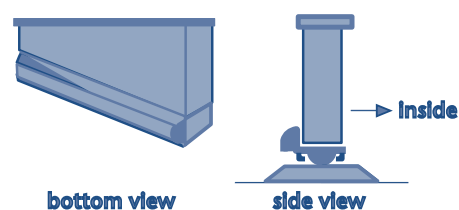

Figure 20: Door shoe.

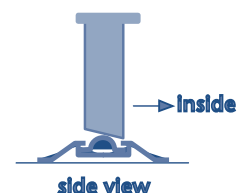

Figure 21: Vinyl bulb threshold.

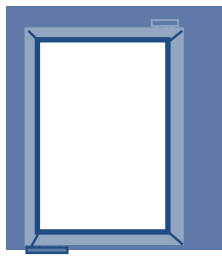

Figure 22: Fixed window.

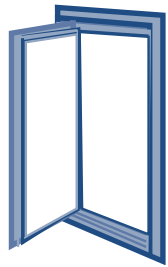

Figure 23: Crank-style casement window.

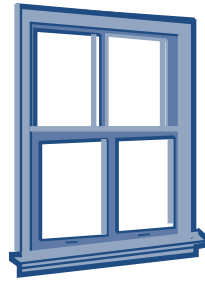

Figure 24: Double-hung window.

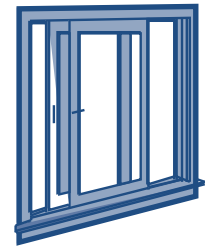

Figure 25: Horizontal sliding window.

If there are air leaks, apply caulking around the outer edges where the glass fits in the frame. A clear silicone caulk is easy to apply and will probably look the best.

All opening, or *operable*, windows need weatherstripping because without it, they are very susceptible to air leaks and heat loss. There are three major types of operable windows, plus *jalousie* style windows found in mobile homes.

- **Casement windows** consist of a single sash, hinged at one side, (Figure 23). Most open to the outside and are operated with cranks or levers. *Awning* windows are similar to casement windows, but are generally hinged at the top. To weatherstrip casement or awning windows, open the sash as widely as possible and attach the weatherstripping material around the inside of the frame in such a way that it will be slightly compressed when the sash is in the closed position. The weatherstripping should be stretched tight before it is fixed in place to prevent wrinkles from forming, thus allowing air to infiltrate. Rolled vinyl with a metal backing is a good option for casement or awning windows, due to its durability and ease of installation.
- **Double-hung windows** are very common, especially in older homes. They are composed of two sliding sashes that move vertically through channels in a single frame, (Figure 24). These windows can be difficult to weatherstrip. But on the other hand, they allow the most air infiltration of any window design if left alone.

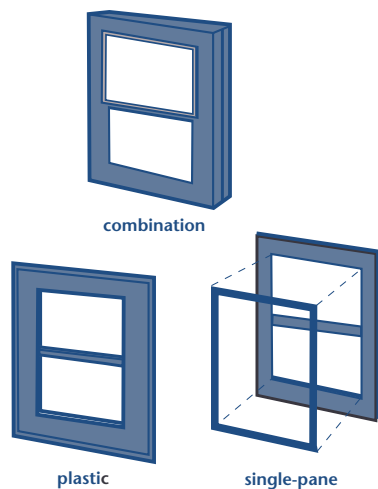

Figure 26: Storm windows.

The channels in the frame are critical areas for air leaks, especially if the windows are old and loose fitting. Use strips of thin spring metal or plastic V-strip to fit in the channels. Open each sash (do one at a time) as wide as it will go and slide the strips in between the sash and channel. The strips should extend one inch beyond the top of the closed sash. This may be difficult for tight-fitting windows. Tack the strips in place, taking care to sink the tacks deeply enough so the sash won't catch on them. Do not cover the pulleys or openings in the upper channels. There are gaskets available for pulley openings that cut out air movement while allowing the ropes to move freely.

The top and bottom edges of the sashes in a double-hung window can be weatherstripped with thin metal strips, rolled vinyl or adhesive-backed foam. Thin strip metal should be used for the inside edges due to the increased friction it will have to withstand. Whatever you choose, be sure to line the entire width of the top and bottom sash rails, (Figures 27-29). Again, make certain that the material is pulled tight and tacked down, so that the sashes can move freely up and down without catching on the frame.

- A **sliding window** is like a double-hung window laid on its side and is equally susceptible to air infiltration, (Figure 25). It can also be weatherstripped in the manner described above. Properly installed thin metal strips in the channels shouldn't interfere with the movement of the sashes. Countersinking the nails will ensure they won't catch on the lower sash rail.
- **Jalousie** or slat-type windows, such as those on mobile homes, require a special weatherstripping material, a clear vinyl channel that slips over the edge of each slat of glass. Finding the correct size and shape may be difficult, but the actual installation is fairly quick and easy.

Window Locks

Rotating "shell"-type locks for sliding or hinged window sashes are the best option for replacing old, worn-out locks, because in the closed position they force the sash against the frame for a tighter seal. Avoid using locks that open a gap between the sash and frame.

Storm Windows

The term *storm window* refers to glazing material (plastic or glass) placed outside or inside an ordinary window. It's not the storm window itself that keeps the warmth inside a house in winter and outside in summer, but the insulating dead-air space between the two windows. For this reason, your permanent windows should first be adequately sealed and weatherstripped to work properly with storm windows. Otherwise the air between them won't be trapped and will be able to circulate and transfer heat.

The least expensive type of storm window is made of temporary plastic sheeting or heat-shrink film. If you can't afford permanent storm windows you might consider these as a temporary solution. To install them, you need four things:

- Six-mil polyethylene plastic in rolls or kits
- Scissors to cut and trim the plastic
- A hammer and tacks, or 2-inch masking tape
- ¼-by-1¼ inch wooden slats

First, measure the width of your larger windows to determine what width of plastic rolls to buy. Then measure the length of your windows to see how many feet of material you'll need to buy.

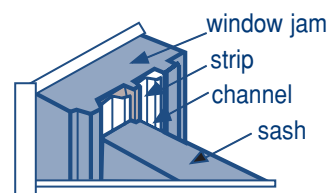

Figure 27: Install plastic v-strips or thin spring metal by moving the sash to the open position and sliding strip in between the sash and the channel. Tack into place. Do not cover the pulleys in the upper channels.

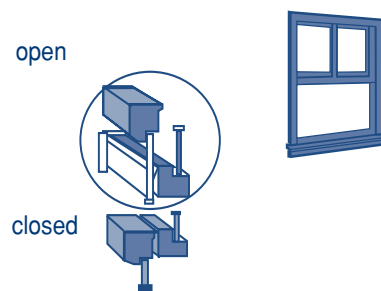

Figure 28: Attach a strip the full width of the window to the bottom rail of the upper sash. Countersink the nails slightly so they won't catch on the top rail of the lower sash.

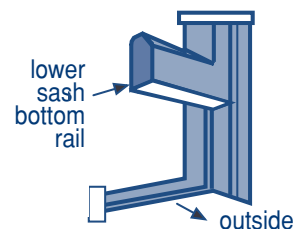

Figure 29: Install strips the full width of the sash on the bottom of the lower sash rail and the top of the upper sash rail.

Attach the plastic to the inside or outside of the window frame so that it will block the airflow that leaks around the moveable parts of the window. If you attach the plastic to the outside, use the slats and tacks. If you attach it to the inside, use masking tape. Inside installation is easier, and the plastic won't be exposed to the elements. Outside installation is more difficult, especially on a multi-story house. Wherever you install it, be sure the plastic is pulled tightly and securely attached to the frame. Trim the excess plastic around the edges. Besides looking better, this will make the plastic less likely to tear in strong winds.

Another common type of storm window has a single pane of glass in a pre-measured aluminum frame. This type is usually fixed in place to the outer frame with a heavy-duty caulking compound or other sealing material. Single-pane storm windows aren't nearly as expensive as double-track or triple-track combination windows and they're effective if properly installed and fitted tightly. However, the major disadvantage is that you can't open them easily once they're installed, (Figure 26).

INFORMATION SOURCES



Caulking and Weatherstripping, U.S. Department of Energy EERE booklet, 3rd edition, April 1992.

Consumer Guide to Home Energy Savings, 4th edition, Alex Wilson and John Morrill, published by the American Council for and Energy-Efficient Economy, Washington, D.C., 1995.

Do-It-Yourself Projects That Save Energy and Money in Your Home, Edison Electric Institute publication #07-81-34.

Energy-Efficient Windows: A Consumer's Guide, U.S. Department of Energy NATAS booklet, DOE-CE-0161.

Home Energy Checklist, Energy Factsheet, U.S. Department of Energy, grant number DE-F847-80CS69097.

Homemade Money, Richard Heebe and the staff of the Rocky Mountain Institute, Birch House Publishing Company, Amherst, NH, 1995.

Keeping the Great Outdoors Outdoors: Caulking and Weatherstripping, published by the Iowa Commerce Commission.

New Mexico Home Energy Guide, published by the New Mexico Energy, Minerals and Natural Resources Dept. and the University of New Mexico, November 1991.

Routine Caulking, Popular Mechanics, April 1992, pp. 84-85.
Saving Energy in Existing Houses, Iowa State University Cooperative Extension Service, August 1984.
Weatherstripping & Caulking Doors & Windows, Iowa State University Cooperative Extension Service, October 1982.

This is an Iowa Energy Center publication.



2521 ELWOOD DRIVE, SUITE 124
AMES, IOWA 50010-8263
515-294-8819 • FAX 515-294-9912

This publication has been updated and modified for use in Arkansas by the Arkansas Department of Economic Development – Energy Unit.



ONE CAPITOL MALL
LITTLE ROCK, AR 72201
501-682-7319 • FAX 501-682-2703
WWW.1800ARKANSAS.COM/ENERGY/

This publication is distributed by:



ARKANSAS

Arkansas Department of
Economic Development
Energy Unit
One Capitol Mall
Little Rock, AR 72201

